

TIAKI Rodent Cage Living Large

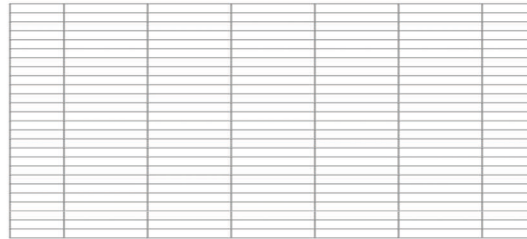

x1



x2

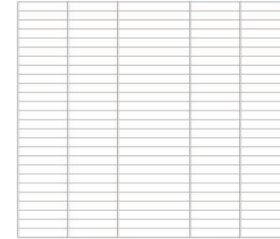

x2



x1



x2

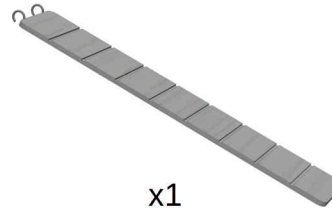

x1



x1



x6 (1x extra)



x2



x2

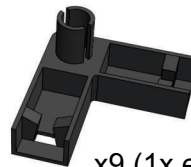

x9 (1x extra)

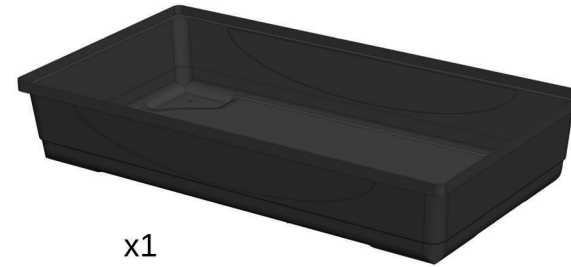

x1



x4



zooplus SE | Sonnenstraße 15 | 80331 München |
 service@zooplus.com Germany | www.zooplus.com
 For GB market: zooplus Services Ltd. |
 30 St. Giles | Oxford | OX1 3LE | England
 Made in Poland



TIAKI Rodent Cage
 Living Large
 LA 388198



4054651017494

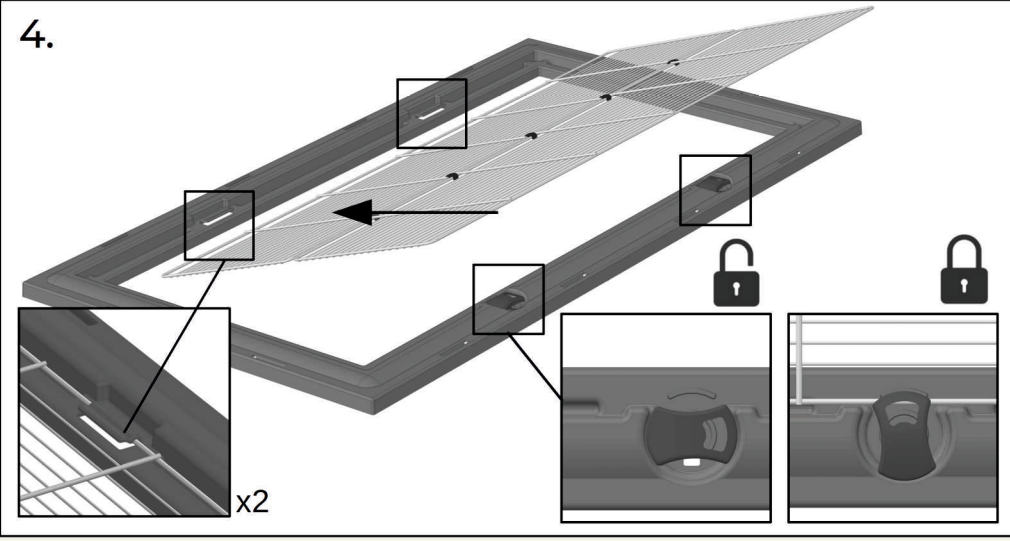
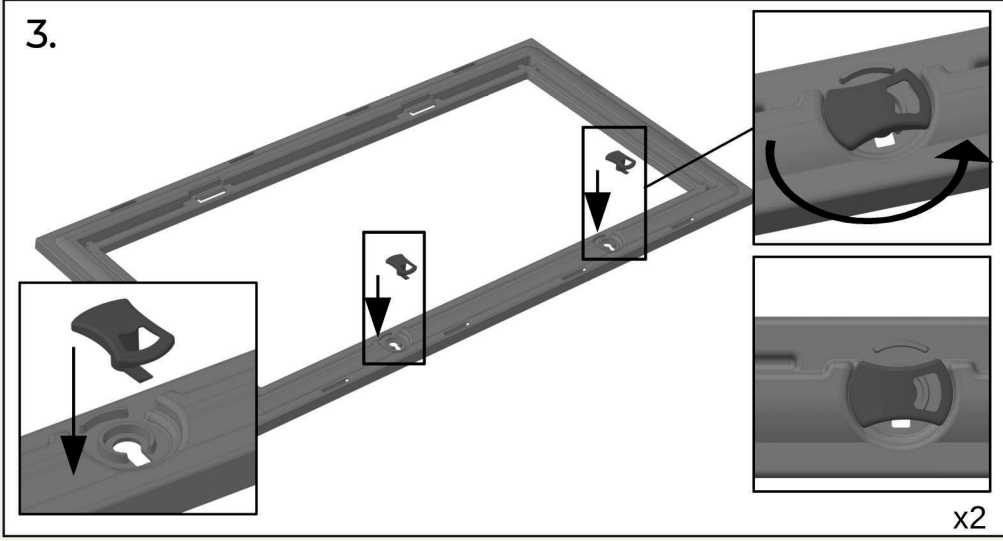
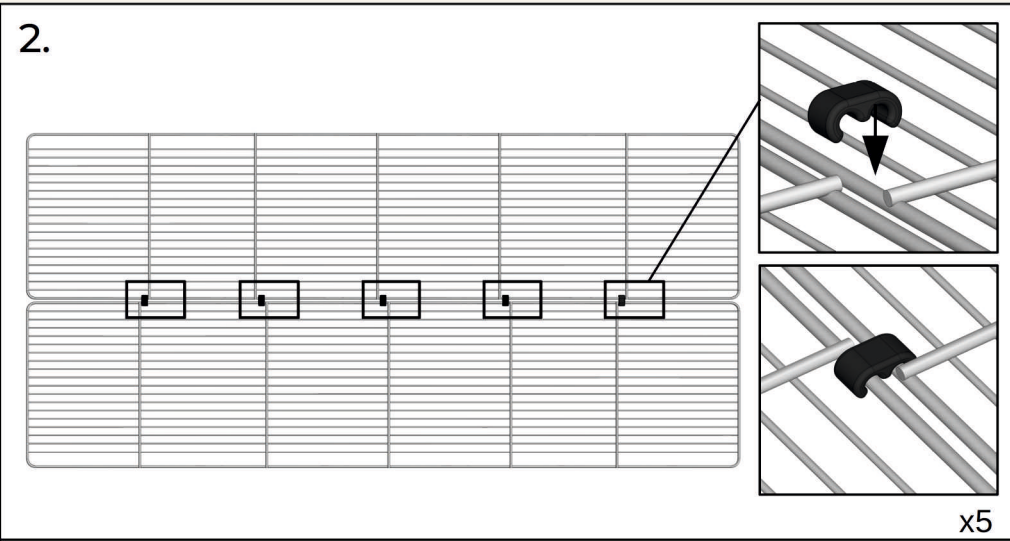
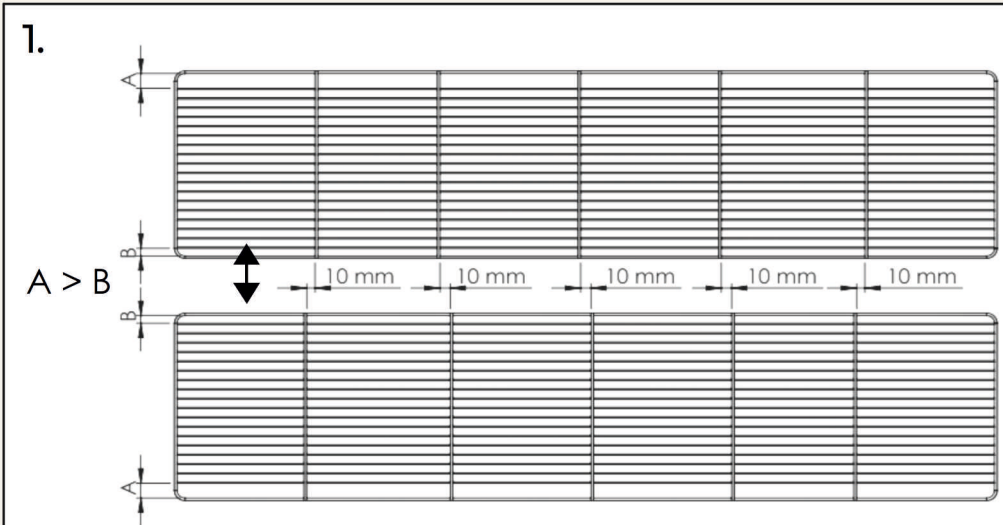

zooplus SE | Sonnenstraße 15 | 80331 München |
 service@zooplus.com Germany | www.zooplus.com
 For GB market: zooplus Services Ltd. |
 30 St. Giles | Oxford | OX1 3LE | England
 Made in Poland

TIAKI Rodent Cage
 Living Large
 LA 388198

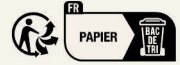

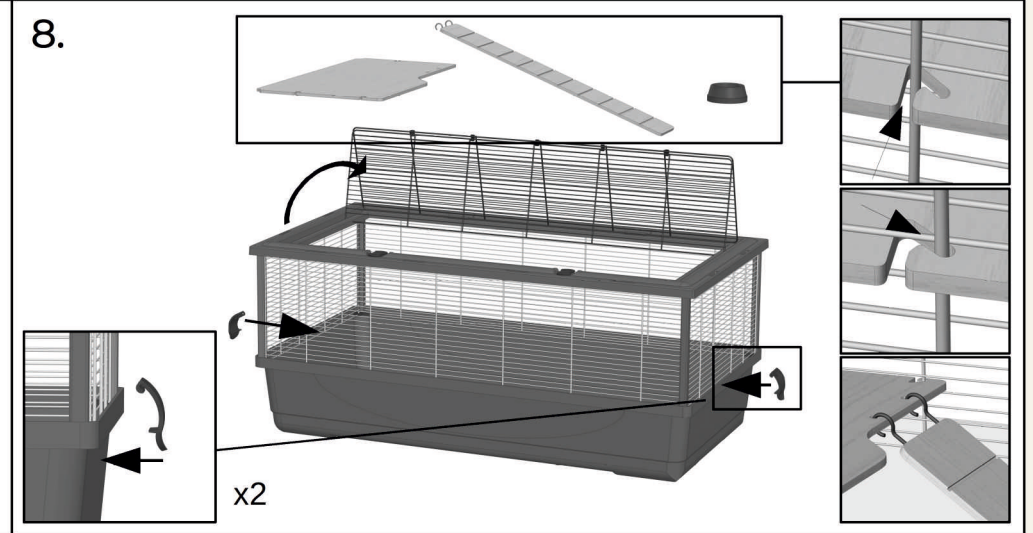
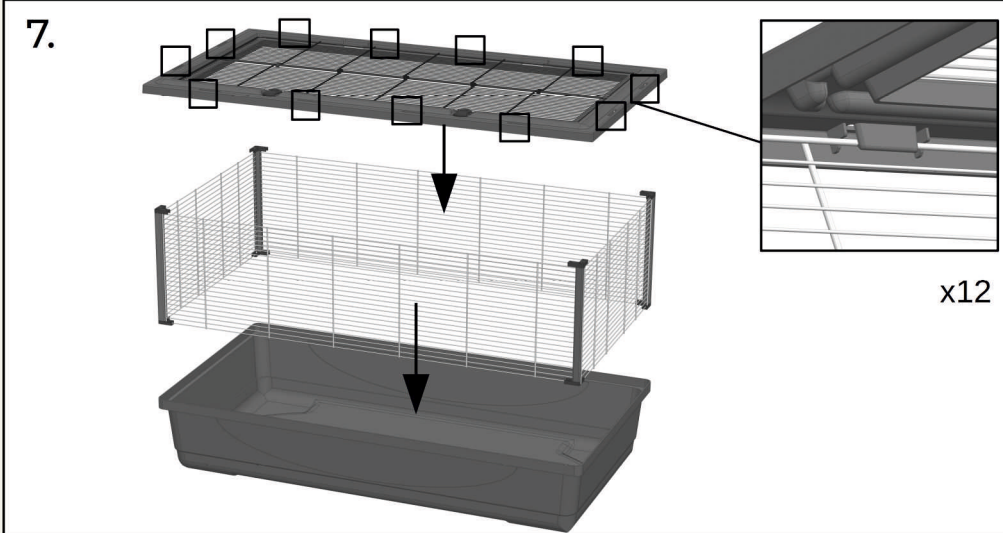
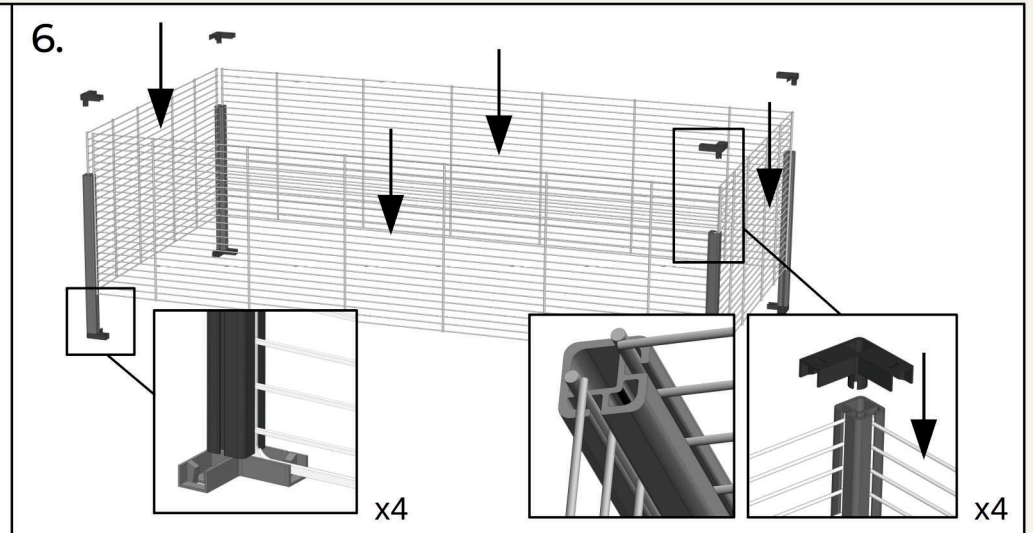
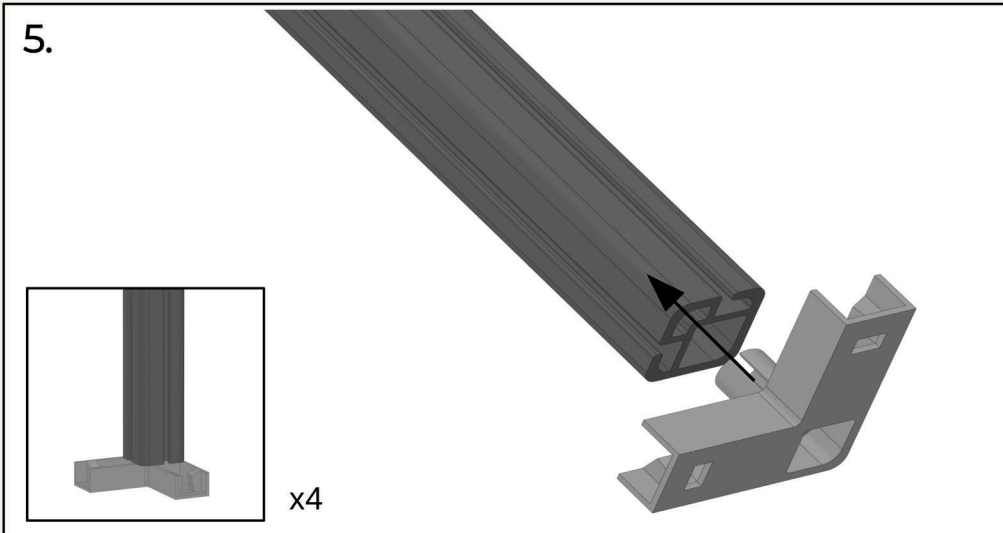

zooplus SE | Sonnenstraße 15 | 80331 München |
 service@zooplus.com Germany | www.zooplus.com
 For GB market: zooplus Services Ltd. |
 30 St. Giles | Oxford | OX1 3LE | England
 Made in Poland



TIAKI Rodent Cage
 Living Large
 LA 388198

